

# Illustration of surface mounted accessory

## ① Accessory list

Ceiling bracket  
\*1PCS

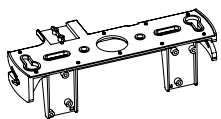

Ceiling housing  
\*1PCS

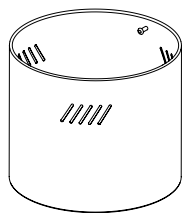

Limiter ring for S9073  
\*1PCS

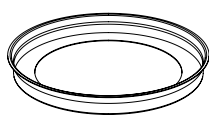

M3\*7 self-tapping  
screws \*2PCS



M4\*25 self-tapping  
screws \*2PCS



Expansion screws  
\*2PCS



## ② Preparation before installation

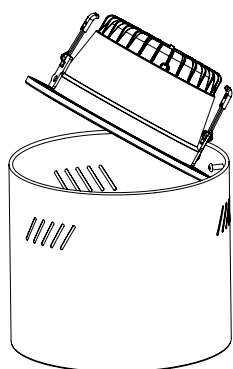
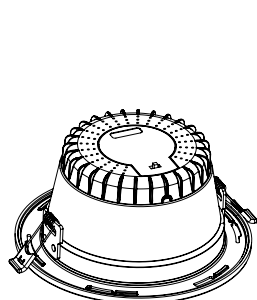

Install downlight into ceiling housing at an angle

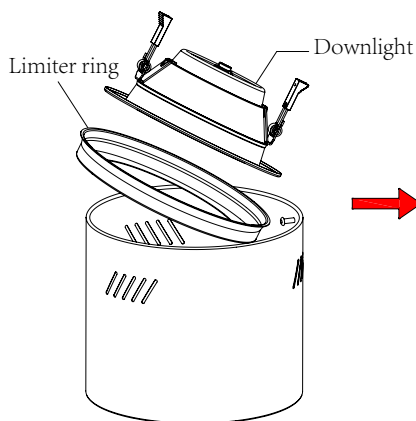

During the installation of the downlight, place the limiter ring into the surface-mounted can, then insert the downlight.

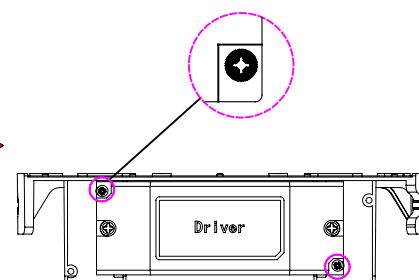

connect the power supply to the ceiling bracket with M3\*7 screws

## ③ Installation instruction

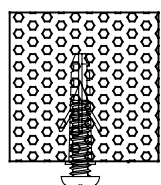

①

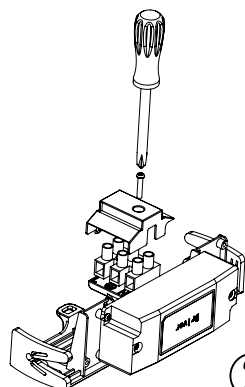

②

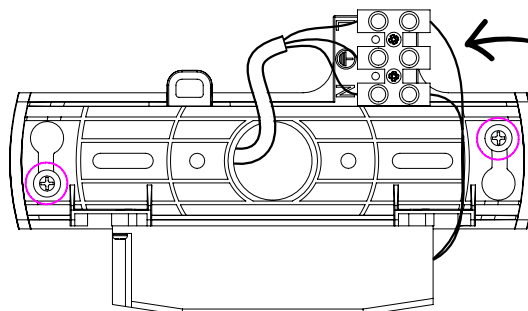

③

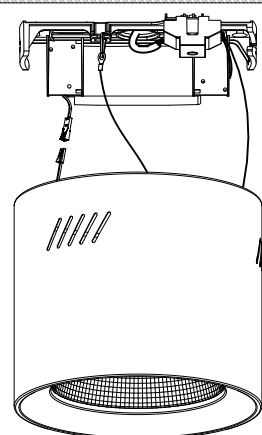
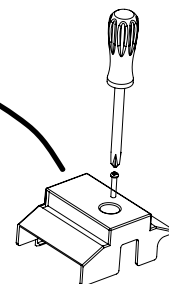

④

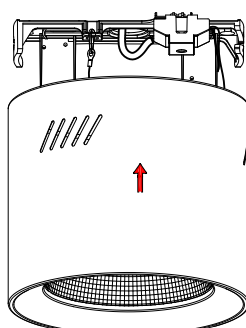

⑤

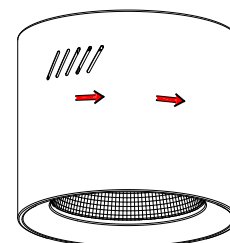

⑥

1. Remove the terminal block cover
2. Install the ceiling bracket and then connect the supply conductors to the terminal and replace the terminal block cover
3. Rotate the ceiling house clockwise and fix it to the ceiling bracket.
4. Lock the safety lanyard and connect the earth conductor and DC output conductors, test and energize